

# ENCLOSURE COOLERS



[WWW.VORTEC.COM](http://WWW.VORTEC.COM)

# About Us

In 1961, Vortec became the first company to develop technology for converting the vortex tube phenomenon into practical, effective industrial cooling solutions. Since then, Vortec has continued to refine and expand vortex tube applications, as well as develop air amplification products for more efficient use of compressed air in blow off and conveying applications. In 1990, Vortec was purchased by Illinois Tool Works, a Fortune 200 company; and is now part of the ITW Air Management business unit, which, in addition to Vortec products, offers the Paxton Product line of products for drying and blow off. Vortec's line of innovative products include:

- **Vortex Tubes, Cold Air Guns, and Vortex Enclosure Coolers for spot and enclosure cooling.**
- **Personal Air Conditioner vests for worker comfort and safety in extreme temperatures.**
- **Energy Saving Nozzles to blow off and clean while conserving compressed air and reducing factory air-related noise and operating costs.**
- **Air Amplifiers, Air Jets and Air Knives for air conveying, surface cooling, static elimination and blowing off of wide areas.**
- **Dual Force Drum Pump for sump clean up and liquid material handling.**

These products and the full line of Vortec products are all designed to improve your facility maintenance and productivity, increase equipment efficiency, and improve manufacturing methods and costs for cooling, cleaning and conveying.

The ITW Air Management team of design and technical application engineers have decades of experience and can help you to find a solution for your industrial and commercial applications. Vortec products are often incorporated into other machinery and equipment to maximize productivity and reliability.

Highly reliable Vortec products are backed by a best-in-class 10 year Warranty for all core, compressed air products that we manufacture. Our entire staff is committed to the quality and dependability and continuous improvement of our products. Please don't hesitate to contact us if you have questions or suggestions.

## About Vortex Tube Technology

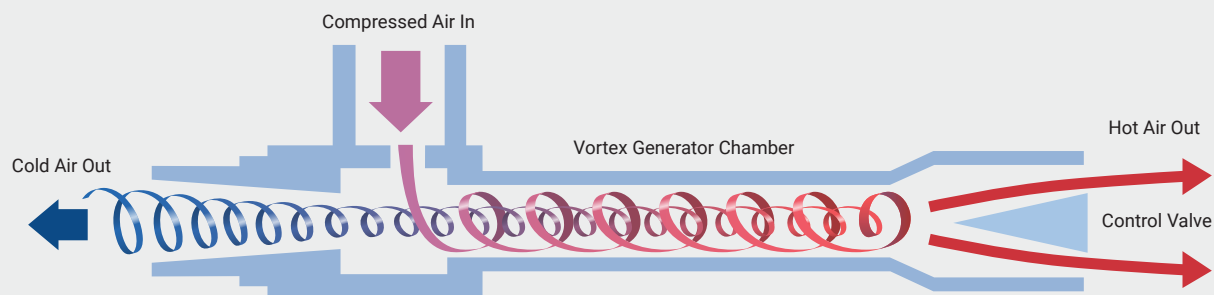

Air that rotates around an axis (like a tornado) is called a vortex. A Vortex Tube creates cold air and hot air by forcing compressed air through a generation chamber, which spins the air at a high rate of speed (1,000,000 rpm) into a vortex. The high speed air heats up as it spins along the inner walls of the tube toward the control valve. A percentage of the hot, high speed air is permitted to exit at the valve. The remainder of the (now slower) air stream is forced to counter flow through the center of the high speed air stream in a second vortex. The slower moving air gives up energy in the form of heat and becomes cooled as it spins up the tube. The inside counter flow vortex exits the opposite end as extremely cold air. Vortex tubes generate temperatures as much as 100°F (56°C) below the inlet air temperature. The fraction of hot air exhausted can be varied to change the outlet cold air temperature, with more exhaust resulting in a colder cold air stream (with lower flow rate), and less exhaust resulting in a warmer cold air stream (and higher flow rate).



# Find Your Product

Is the location classified as hazardous?

NO

How precisely do you need to control the temperature in the enclosure?

Precise to  $\pm 5^{\circ}\text{F}$

See **Vortex A/C**

PAGE  
4

Precise to  $\pm 2^{\circ}\text{F}$

See **Electric Vortex A/C**

PAGE  
6

YES

What is the location rating?

UL Class I Div 2, Class II Div 2,  
and Class III; T4

See **HazLoc**

PAGE  
8

ATEX Zones 2 and 22; T4

See **ATEX**

PAGE  
10

UL Class 1 Div 1  
ATEX Zones 1 and 21; T3

See **ProtEX**

PAGE  
12

Need help choosing a cooler?

Check out our  
**Heat Load Calculator**  
online

[VORTEC.COM/HEATLOAD/CALCULATOR](https://vortec.com/heatload/calculator)

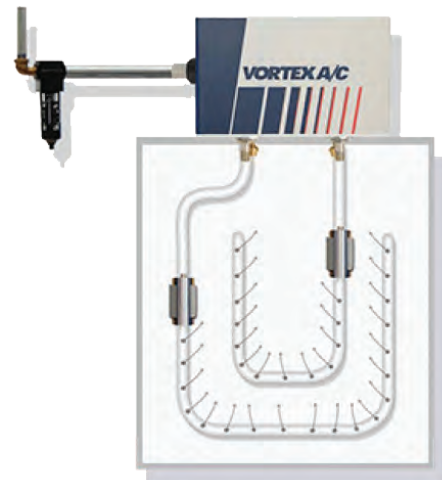

# Vortex A/C

Vortex A/C units are a new generation of enclosure coolers which incorporate a sleek, modern design, noise reduction, and an integrated thermostat for quick, easy installation and trouble-free operation.

Vortex A/C Enclosure Coolers improve upon Vortec's line of highly reliable, cost effective enclosure coolers and are available in four different cooling capacities with ratings of NEMA 12, NEMA 4 and NEMA 4X. Hazardous Location options are shown on pages 8–13.

## Benefits

- Very quiet, 62 dBA operation - 78% quieter than standard vortex tube coolers
- Thermostatically controlled to maintain enclosure temperatures within 70°F and 100°F (21°C–38°C)
- Reduces operating costs - only runs when necessary
- Flexible mounting options - top, side or front (door)
- No wiring required for installation - 5 minute install
- Little to no maintenance costs, compared to Freon A/C and fans
- Operates in environments up to 175°F (80°C)
- Multiple cooling capacities available, to optimize performance and operating cost

## Features

- Polycarbonate box with noise reduction muffling
- Integrated mechanical thermostat
- Create true refrigeration using only compressed air
- Maintain sealed nature of NEMA and JIC boxes
- Maintains slight pressurization in the enclosure while operating
- Incorporates a relief valve to prevent over pressurization
- Mounts in standard electrical knockout
- Highly reliable, no moving parts
- UL Listed, File E187045



## Case Study

**The Problem:** A major producer of high-quality metallurgical coke for the steel industry was experiencing erratic behavior of their control systems due to excessive heat buildup in their outdoor furnace monitoring controls. The outdoor controls were exposed to temperatures climbing near 100°F (38°C) while being adjacent to the coke furnaces which get up to 2400°F (1316°C).

**The Solution:** Vortec Engineers and site engineers discussed the problem and determined that the best solution was the Vortex A/C model 7715. Its easy installation and integrated mechanical thermostat were the main deciding factors.

**Conclusion:** The site engineer could not be happier with the Vortex A/C. The harsh environments wreaked havoc on other cooling products and the Vortex A/C was the only solution found that could withstand the environment.



## 7670 & 7770 Vortex A/C

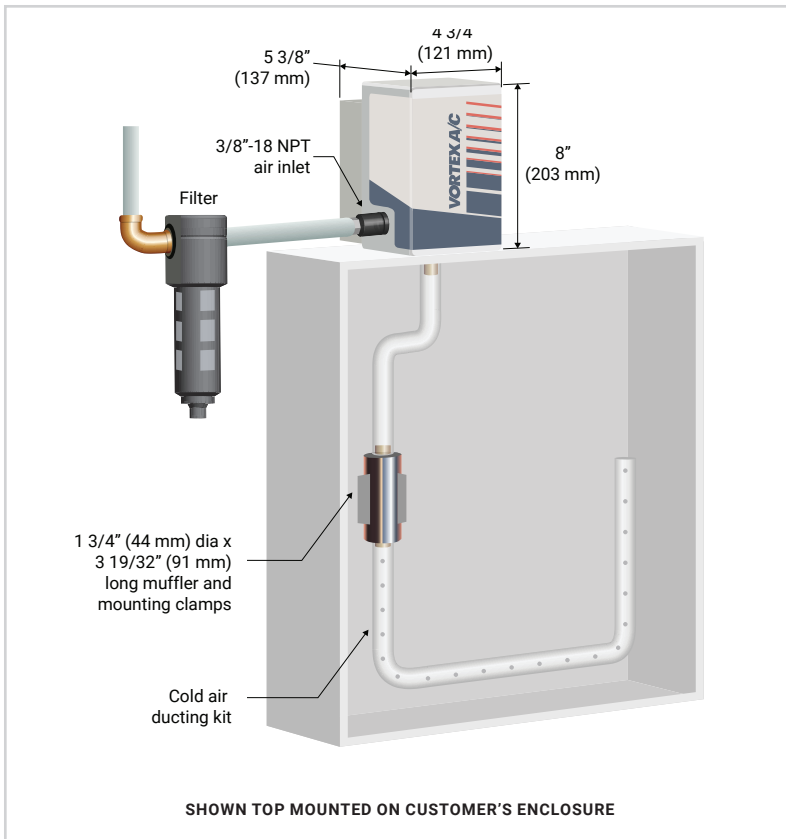

## 76x5 & 77x5 Vortex A/C

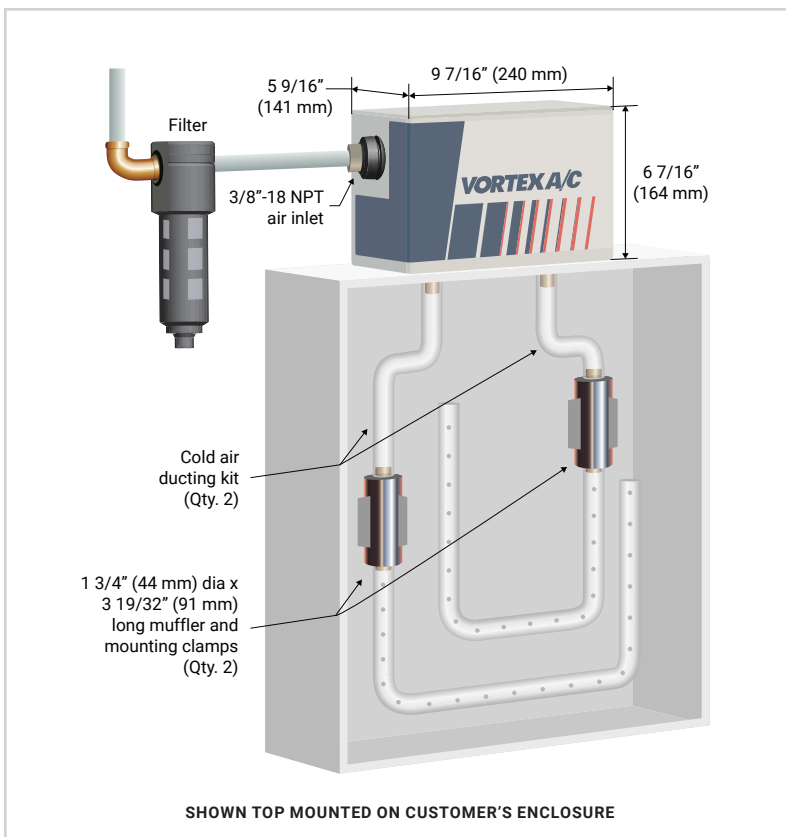

## Specifications

### NEMA 12

Thermostat Option: Mechanical  
Sound Level: Quiet

Model	Cooling Capacity BTU/hr (Watts)	Air Consumption SCFM (SLPM)
7615	900 (264)	15 (425)
7625	1500 (440)	25 (708)
7635	2500 (733)	35 (991)
7670*	5000 (1465)	70 (1981)

### NEMA 4

Thermostat Option: Mechanical  
Sound Level: Quiet

Model	Cooling Capacity BTU/hr (Watts)	Air Consumption SCFM (SLPM)
7715	900 (264)	15 (425)
7725	1500 (440)	25 (708)
7735	2500 (733)	35 (991)
7770*	5000 (1465)	70 (1981)

### NEMA 4X

Thermostat Option: Mechanical  
Sound Level: Quiet

Model	Cooling Capacity BTU/hr (Watts)	Air Consumption SCFM (SLPM)
7715	900 (264)	15 (425)
7725	1500 (440)	25 (708)
7735	2500 (733)	35 (991)
7770*	5000 (1465)	70 (1981)

\* Models 7670 and 7770 are patented two-stage Coolers.

To conserve energy, during low periods of heatload, only one stage is activated via mechanical thermostat.



# Electric Vortex A/C

Electric Vortex A/C Enclosure Coolers are the most advanced line of Vortec enclosure coolers, integrating an electric thermostat in our popular, quiet Vortex A/C design.

The Electric Vortex A/C is yet another innovative compressed air product in Vortec's line of highly reliable, cost effective enclosure coolers. They eliminate all wiring by integrating an electric thermostat to provide a quick and easy installation.

## Benefits

- Very quiet, 62 dBA operation - 78% quieter than standard vortex tube coolers
- No wiring required, comes pre-wired, just plug it in
- Operates effectively at 40–150 psi pressure levels, does not require a specific pressure
- Thermostatically controlled to maintain user defined setting between 35°F and 140°F (2°C–60°C)
- Operates in environments up to 175°F (80°C)
- Reduces operating cost with electric thermostat turning the unit on only when necessary
- Multiple cooling capacities available, to optimize performance and operating cost
- Little to no maintenance required

## Features

- Polycarbonate box with noise reduction muffling
- Integrated electric thermostat which can be placed anywhere within enclosure
- Create true refrigeration using only compressed air
- Maintain sealed nature of NEMA and JIC boxes
- Maintains slight pressurization in the enclosure, while operating
- Incorporate relief valve to prevent over pressurization
- Mounts in standard electrical knockout
- Highly reliable, no moving parts
- UL Listed, File E187045
- 120 volt or 240 volt models available



## Case Study

**The Problem:** A Big Three automaker needed a quick fix to prevent control systems from overheating, which was impacting their automation and production processes at one of their main manufacturing plants.

**The Solution:** Their Plant Manager contacted Vortec and discussed the problem and their need for a reliable cooling solution. Electric thermostat controls were needed to keep electronics at a precise constant temperature per manufacturer guidelines but minimal installation time and costs were required. Our Application Engineers directed them to the Vortec Electric Vortex A/C unit which includes an integrated electric thermostat, requires no additional wiring and installs in ten minutes or less.

**Conclusion:** All the units were installed within minutes and all production issues were resolved, allowing production to resume and continue uninterrupted normal operation.



## 77x5EB Electric Vortex A/C

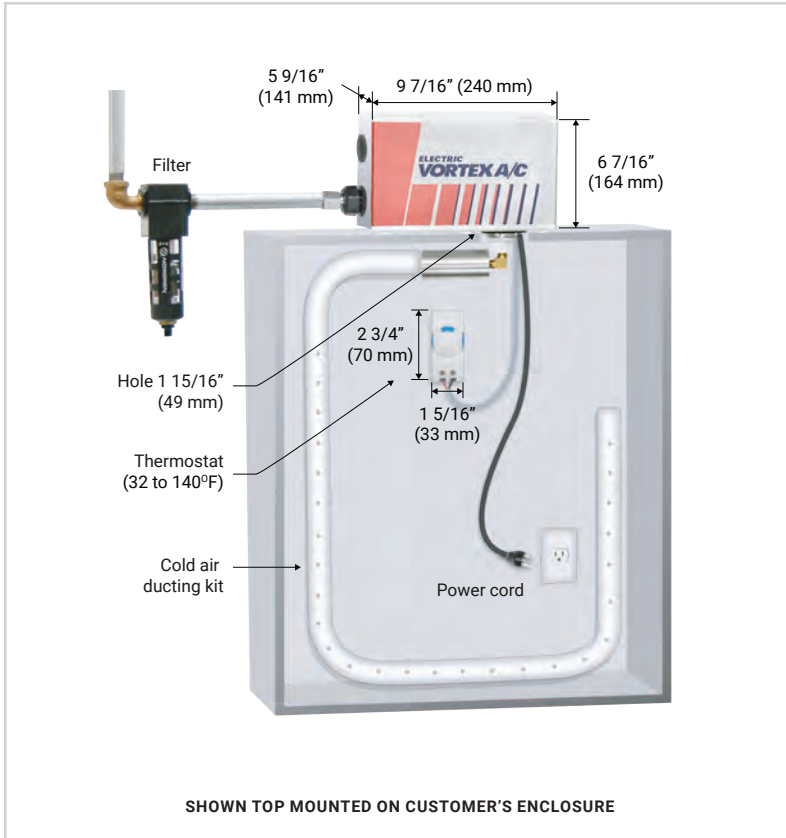

## 77x5ES Electric Vortex A/C

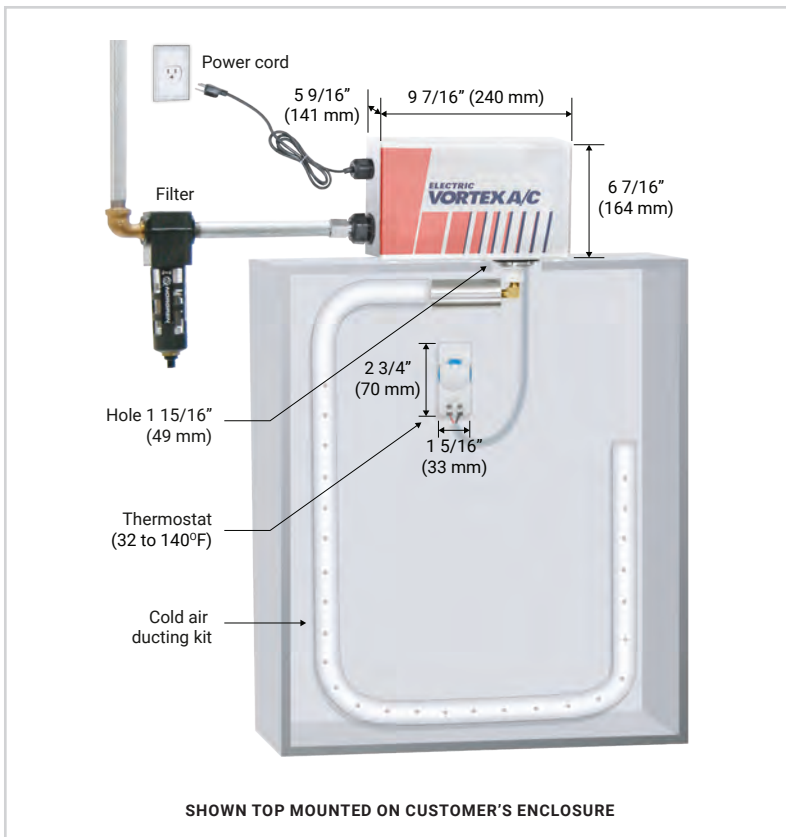

## Specifications

NEMA 4X	
Cord: Inside Enclosure Sound Level: Quiet	
Model*	Cooling Capacity BTU/hr (Watts)
7715EB	900 (264)
7725EB	1500 (440)
7735EB	2500 (733)

NEMA 4X	
Cord: Outside Enclosure Sound Level: Quiet	
Model*	Cooling Capacity BTU/hr (Watts)
7715ES	900 (264)
7725ES	1500 (440)
7735ES	2500 (733)

\* Add "F" to the end of model number to denote 240 volt option.



# HazLoc Vortex A/C

Hazardous Location (HazLoc) Vortex A/C Coolers provide all the benefits of the Vortex A/C while providing protection in Class I Div 2, Groups A, B, C & D; Class II Div 2, Groups F&G and Class III locations.

The HazLoc Vortex A/C is UL Classified and is designed specifically for purged\* electrical enclosures to provide protection to sensitive electronics in hazardous locations.

## Benefits

- Reduces operating costs with mechanical thermostat which maintains enclosure temperatures within 75°F and 100°F (24°C–38°C)
- Very quiet, 62 dBA operation - 78% quieter than standard vortex tube coolers
- Flexible mounting options - top, side or front (door)
- No wiring required for installation - 5 minute install
- Significantly lower up front and maintenance costs, compared to explosion proof Freon air conditioners
- Operates in environments up to 175°F (80°C)
- Multiple cooling capacities available, to optimize performance and operating cost

## Features

- UL Classified for Class I Div 2, Groups A, B, C & D; Class II Div 2, Groups F&G and Class III locations with T4 temp rating
- Type 4/4X rating
- Integrated mechanical thermostat
- Designed to be used with a purge system\*
- Create true refrigeration using only compressed air
- Maintain sealed nature of NEMA and JIC boxes
- Mounts in standard electrical knockout
- Highly reliable, no moving parts
- UL Classified, File E356284

\* Purge system not included with purchase



## Case Study

**The Problem:** A major oil refinery in Texas was experiencing production problems due to a control panel which was very sensitive to the hot Texas sun. A low cost, reliable solution was needed in order to correct this deficiency and maintain required production levels.

**The Solution:** The Maintenance Manager contacted Vortec and discussed the problem as well as the need to maintain the Class 1 Div 2 requirement. The customer stated that air conditioners were not an option as they were too costly and the maintenance requirements were too high. Vortec educated him on the HazLoc Vortex A/C and its integrated mechanical thermostat, Class 1 Div 2 certification and extremely low maintenance need, as there are no moving parts.

**Conclusion:** The company purchased five HazLoc units, installed them and to-date, have experienced no production disruptions as well as no downtime due to maintenance needs.





## 75x5 Hazardous Location Vortex A/C

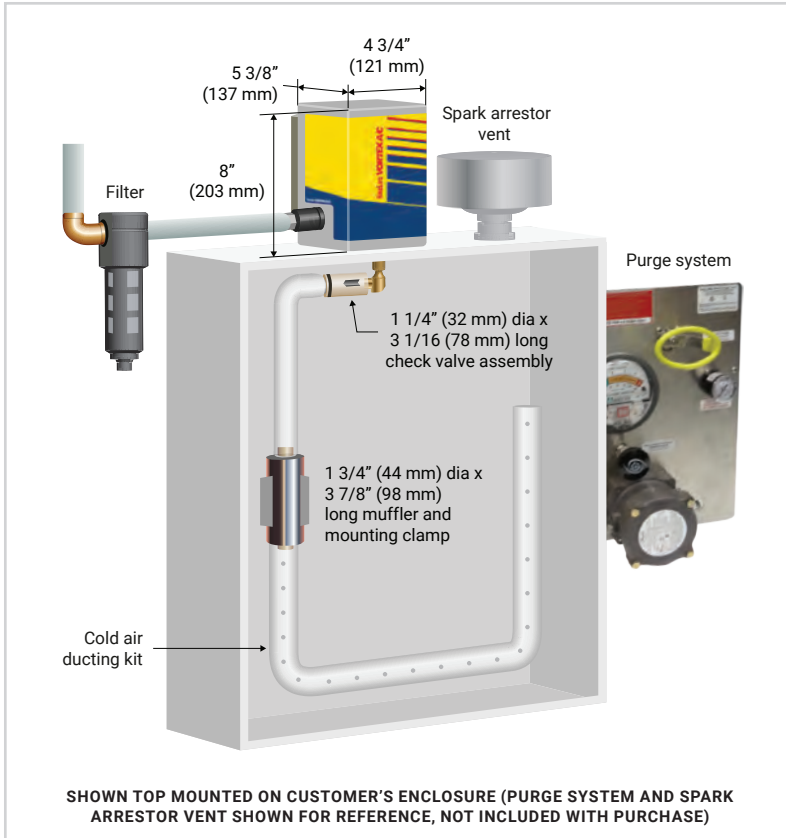

## Specifications

HazLoc	
Thermostat Option: Mechanical Sound Level: Quiet	
Model	Cooling Capacity BTU/hr (Watts)
7515	900 (264)
7525	1500 (440)
7535	2500 (733)
7570*	5000 (1465)

\* Model 7570 is a two-stage Cooler.

To conserve energy, during low periods of heatload, only one stage is activated via mechanical thermostat.

## 7570 Hazardous Location Vortex A/C

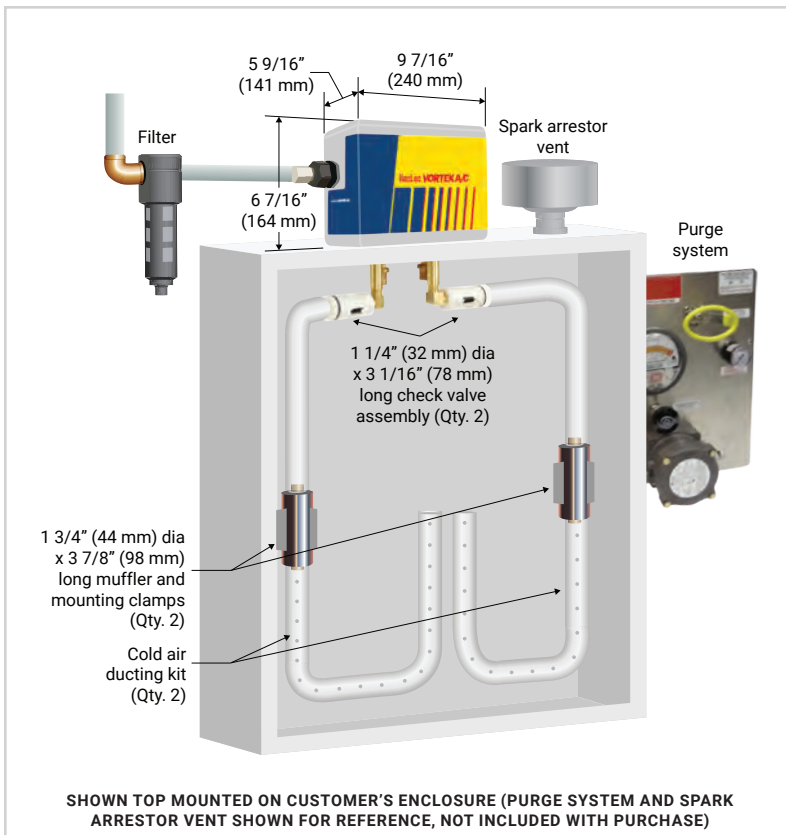

# ATEX Vortex A/C

ATEX Vortex A/C Coolers take the HazLoc design one step further by providing protection in ATEX Zones 2 and 22 and Temperature Class T4 areas.

The ATEX Vortex A/C is designed specifically for purged\* systems and is ATEX certified for Zone 2 and 22 hazardous locations (Ex II 3 GD T4).

## Benefits

- Reduces operating costs with mechanical thermostat which maintains enclosure temperatures within 75°F and 100°F (24°C–38°C)
- Very quiet, 62 dBA operation - 78% quieter than standard vortex tube coolers
- Flexible mounting options - top, side or front (door)
- No wiring required for installation - 5 minute install
- Significantly lower up front and maintenance costs, compared to explosion proof Freon air conditioners
- Operates in environments up to 175°F (80°C)
- Multiple cooling capacities available, to optimize performance and operating cost

## Features

- ATEX Certified Ex II 3 GD T4
- Tamb -20°C to 80°C (-4°F to 175°F)
- Compression molded fiberglass box with noise reduction muffling
- Integrated mechanical thermostat
- Designed to be used with a purge system\*
- Create true refrigeration using only compressed air
- Maintain sealed nature of NEMA and JIC boxes
- Mounts in standard electrical knockout
- Highly reliable, no moving parts
- Certificate No. Baseefa14ATEX0267X

\* Purge system not included with purchase



## Case Study

**The Problem:** A European refinery had a need for reliable, cost effective cooling on control panels which housed electronics for their gas monitoring equipment. ATEX Air Conditioners had been used in the past but they were having difficulties standing up to the harsh conditions in this area of the plant.

**The Solution:** In discussions with the customer, the Vortec Distributor identified the ATEX Vortex A/C as the perfect solution. The integrated mechanical thermostat perfectly fit the electronics' needs to maintain temperatures between 24°C and 38°C. Additionally, the Ex II 3 GD T4 rating was what their location required. Maintenance requirements were negligible due to no moving parts.

**Conclusion:** After installation, the facility reduced downtime by almost 100% and incurred no maintenance downtime due to filter replacement or product failures.



## 74x5 ATEX Vortex A/C

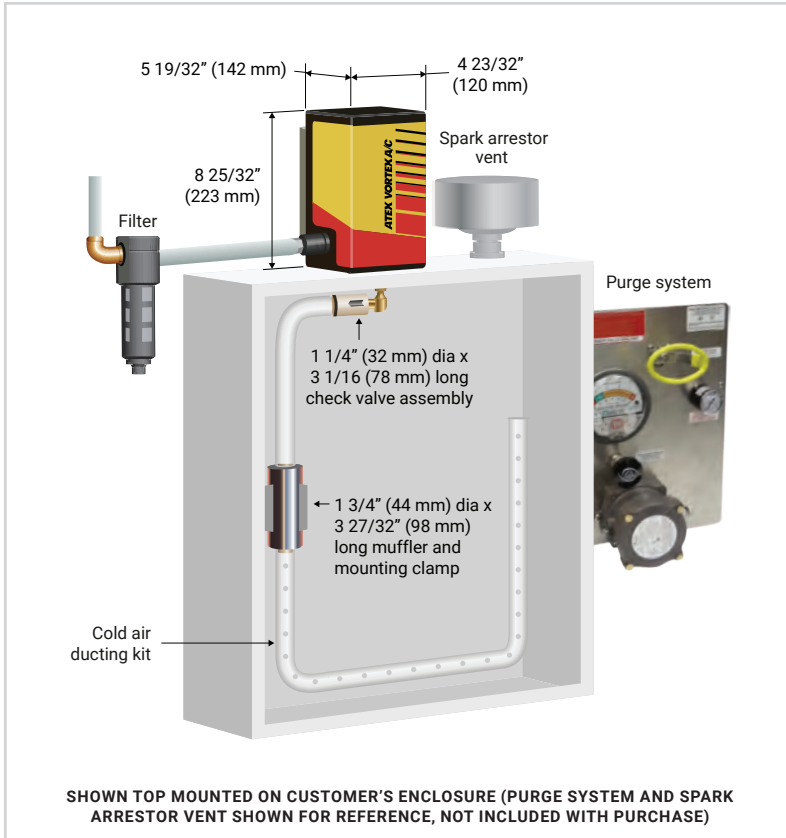

## 7470 ATEX Vortex A/C

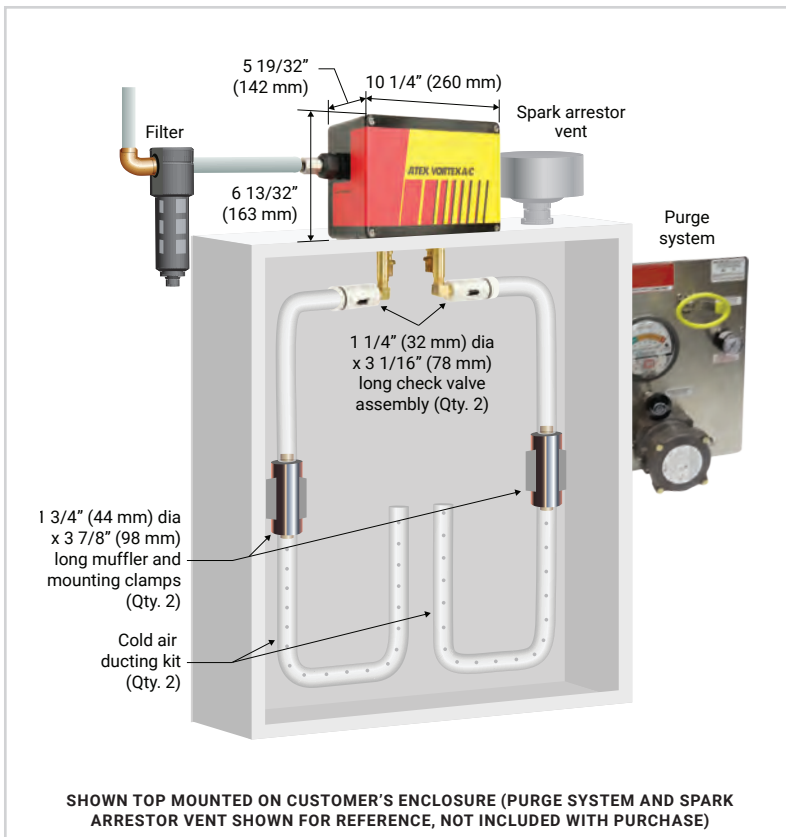

## Specifications

ATEX	
Thermostat Option: Mechanical Sound Level: Quiet	
Model	Cooling Capacity BTU/hr (Watts)
7415	900 (264)
7425	1500 (440)
7435	2500 (733)
7470*	5000 (1465)

\* Model 7470 is a two-stage Cooler.

To conserve energy, during low periods of heatload, only one stage is activated via mechanical thermostat.



# ProtEX Vortex A/C

ProtEX Vortex A/C Coolers are designed specifically for purged\* Electrical enclosures in ATEX Zones 1 and 21 and UL Class I Division 1, Temperature Class T3 areas.

The ProtEX Vortex AC takes the HazLoc and ATEX designs to a new level to provide protection in the most hazardous areas, ATEX Zones 1 and 21 and UL Class I Division 1.

\* Purge system not included with purchase

## Benefits

- Reduces operating costs with mechanical thermostat which maintains enclosure temperatures within 75°F and 100°F (24°C–38°C)
- Very quiet, 62 dBA operation, 78% quieter than typical vortex coolers
- Flexible mounting options - top, side or front (door)
- No wiring required for installation - 5 minute install
- Significantly lower up front and maintenance costs, compared to explosion proof Freon air conditioners
- Operates in environments up to 175°F (80°C)
- Multiple cooling capacities available, to optimize performance and operating cost

## Features

- ATEX Certified, Cert No. Baseefa16ATEX0166X
- Ex h IIC T3 Gb
- Ex h IIIC T200°C Db
- Ta +10°C to +80°C (50°F to 175°F)
- UL Classified, File E356284
- Class I, Division 1, Groups A, B, C & D
- Class II, Division 1, Groups F & G
- Class III
- Temperature Class T3 Areas
- 3 year warranty



## Why Choose ProtEX Vortex A/C Coolers?

"The ATEX Certification means that industrial facilities can now save thousands of dollars while cooling electrical, electronic and control system enclosures in ATEX Zones 1 and 21," said the Vortec Engineering Manager.

"Previously, industrial facility managers had to purchase large, heavy and expensive hazardous location air conditioners – a large initial investment with ongoing maintenance costs. The new ProtEX models are a small, economical, easily installed alternative with low maintenance costs."



## 8170 ProtEX Vortex A/C

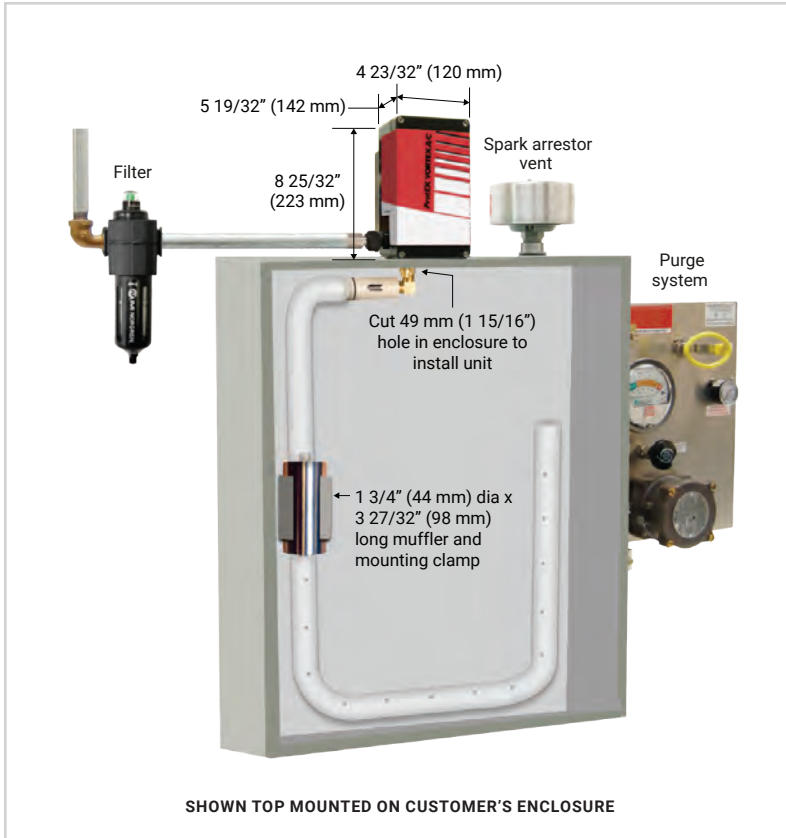

## Specifications

Zone 1 & 21	
Thermostat Option: Mechanical Sound Level: Quiet	
Model	Cooling Capacity BTU/hr (Watts)
8115	900 (264)
8125	1500 (440)
8135	2500 (733)
8170*	5000 (1465)

\* Model 8170 is a two-stage Cooler.  
To conserve energy, during low periods of heatload, only one stage is activated via mechanical thermostat.

## 81x5 ProtEX Vortex A/C

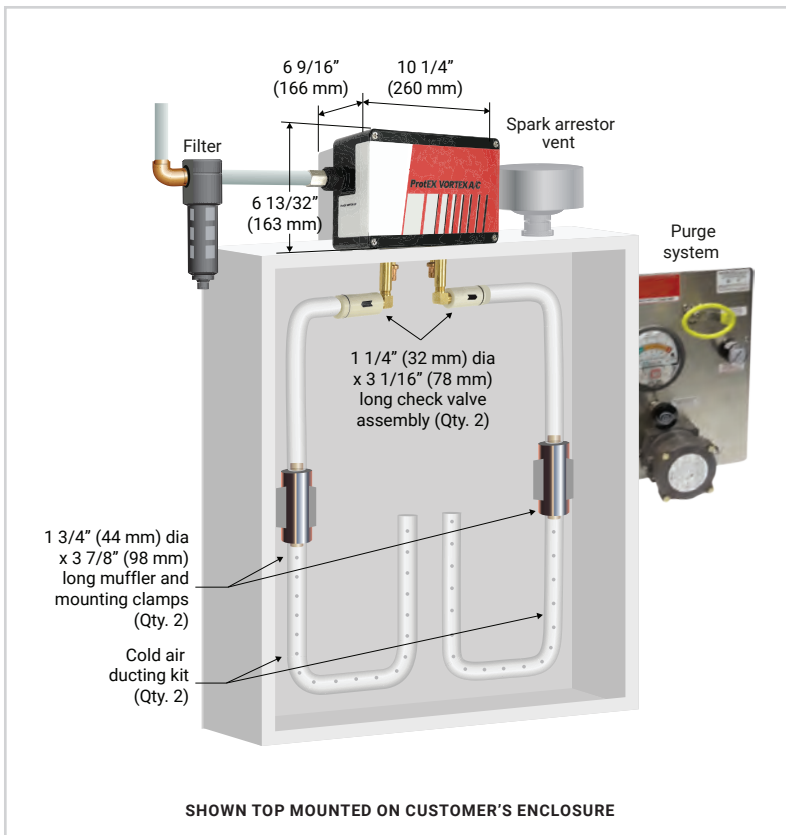



# Panel Guard

Panel Guard Enclosure Coolers improve upon the original Vortec Cooler line by incorporating a mechanical thermostat for optimum temperature control and elimination of the need for wiring.

Panel Guard models provide quick, easy installation while maintaining the energy use reduction advantages of using a thermostat. Panel Guard Enclosure Coolers are available in 3 different cooling capacities and are rated for NEMA 4 enclosures.

## Benefits

- Easy to install in about 5 minutes
- No wiring required to install
- Reduces operating costs with mechanical thermostat which maintains enclosure temperatures within 75°F and 100°F (24°C - 38°C)
- Multiple cooling capacities available, to optimize performance and operating cost
- No ambient, dirty or humid air enters the cabinet,
- Can be used on all NEMA 4 cabinets, even in tight spaces
- Operates in environments up to 175°F (80°C)
- Low cost, compared to Freon air conditioners

## Features

- No electricity required
- Integrated mechanical thermostat
- Create true refrigeration using only compressed air
- Maintain sealed nature of NEMA and JIC boxes
- Maintains slight pressurization in the enclosure, while running
- Incorporate relief valve to prevent over pressurization
- Mounts in standard electrical knockout
- Highly reliable, no moving parts
- UL listed, File E187045



## Case Study

**The Problem:** A top fertilizer manufacturer was experiencing down time due to conveyor controls overheating. This led to lost revenue as well as increased maintenance costs.

**The Solution:** After a view of the facility, conditions and problems being encountered, Vortec engineers and site engineers calculated heatload and cooling requirements and decided that the Panel Guard Enclosure Cooler was the optimum solution for their needs. The main deciding factor was the integrated mechanical thermostat as the electrical thermostat solutions were a concern in the environment.

**Conclusion:** Since incorporating the Panel Guard Enclosure Cooler, this customer has experienced no downtime and production is running at optimum levels with reduced maintenance costs.





## 770 Panel Guard

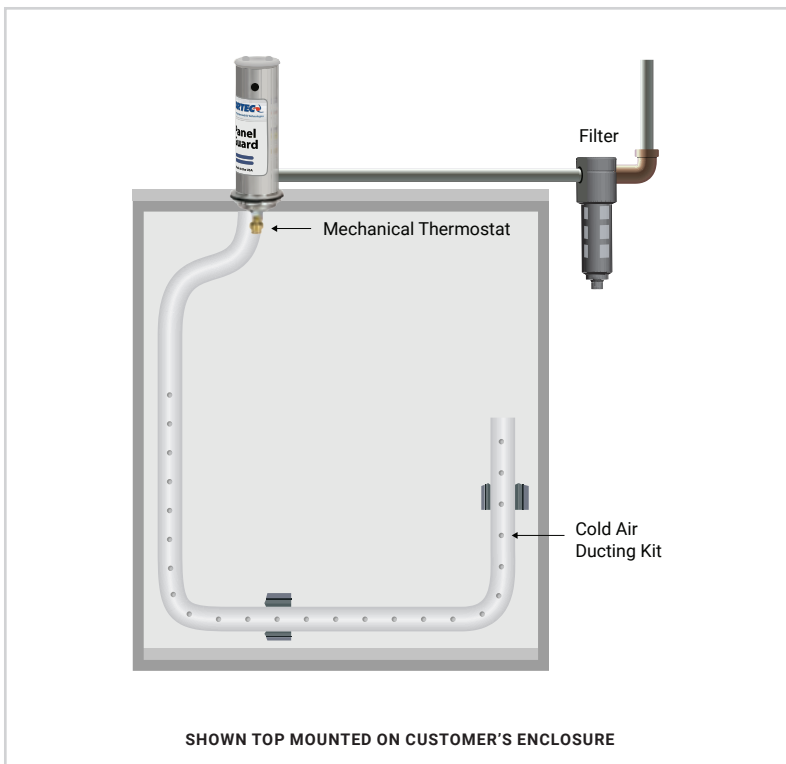

## Specifications

NEMA 4	
Thermostat Option: Mechanical Sound Level: Standard	
Model	Cooling Capacity BTU/hr (Watts)
770-15H	900 (264)
770	1500 (440)
770-35H	2500 (733)

If you've used these in the past, check out the new and improved Vortex A/C's on page 4.

They provide the same reliability you've come to expect with the panel guard coolers while providing the latest technology and reducing compressed air noise by 78%.

# Vortex Coolers

Vortex Coolers are first generation vortex tube enclosure coolers and refrigerate compressed air to offset heat buildups in control panels.

Vortex Enclosure Coolers are available in NEMA 12, NEMA 4 and NEMA 4X versions, and can be purchased with an electric thermostat or without a thermostat (constant run).

## Benefits

- Thermostatically controlled models maintain enclosure temperatures within customer set range and reduce operating cost
- Highly reliable, no moving parts
- No ambient, dirty or humid air enters the cabinet
- Can be used on all cabinets, even in tight spaces
- Multiple cooling capacities available, to optimize performance and operating cost
- Operates in environments up to 175°F (80°C)
- Low cost, compared to Freon air conditioners

## Features

- Constant run and electric thermostat models available
- Electric thermostat models can be set to desired temperature +/- 2°F (+/- 1°C)
- Create true refrigeration using only compressed air
- Maintain sealed nature of NEMA and JIC boxes
- Maintains slight pressurization in the enclosure, while running
- Incorporate relief valve to prevent over pressurization
- Mounts in standard electrical knockout
- UL Listed, File E187045



## Case Study

**The Problem:** A metal stamping plant that provides parts to automotive OEMs was experiencing overheating issues with the control panels that house the electronics for their stamping equipment. As a result, their lines would have to shutdown 2 times a week for an hour each costing them \$1,500 an hour in lost revenue as well as idle employee time.

**The Solution:** The Maintenance Supervisor was directed to Vortec by a colleague and in speaking with an Application engineer was directed toward the 7970 Dual Vortex Enclosure Cooler. He was sold on the fact that there was no freon needed, no fans to break down and little maintenance needed.

**Conclusion:** The Maintenance Supervisor ordered one 7970 for one line as a trial and was so impressed with it that he quickly ordered three more for each of the other lines. Since using the 7970 Vortex Cooler he has experienced no downtime, no maintenance costs and no overheating issues.

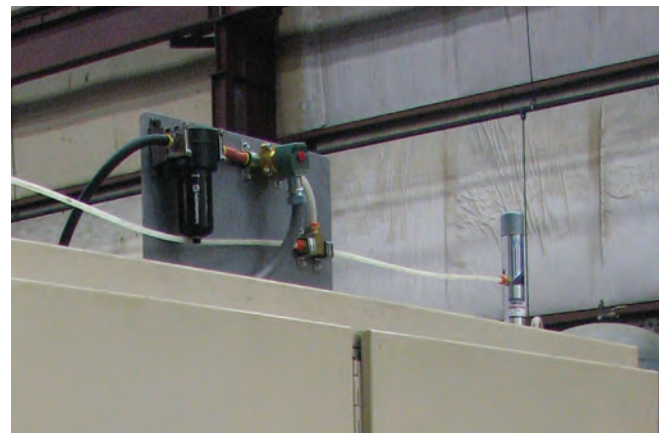

Note: Constant run Vortex Coolers use significantly more compressed air than thermostatically controlled units.

## NEMA 12 / 400 BTUH

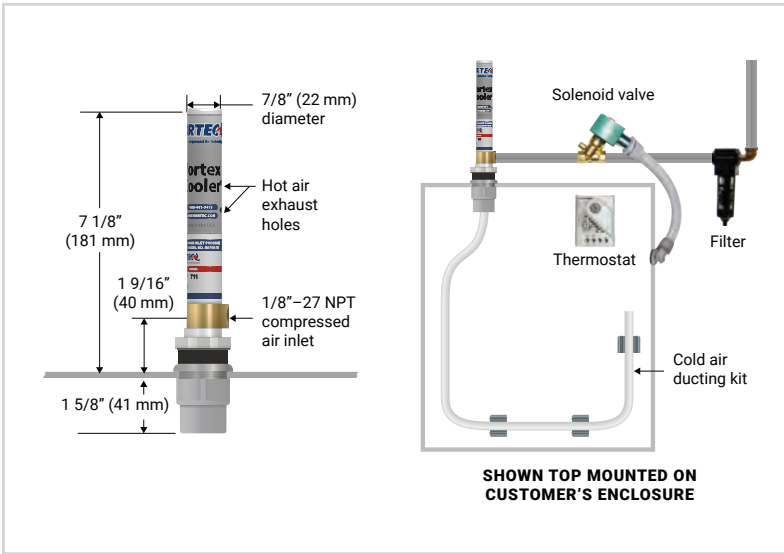

## NEMA 12 / 900-2500 BTUH

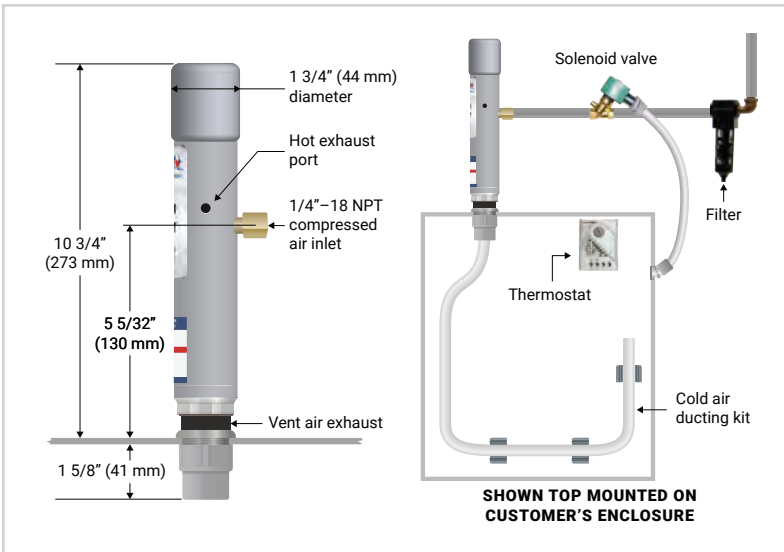

## NEMA 4/4X / 900-2500 BTUH

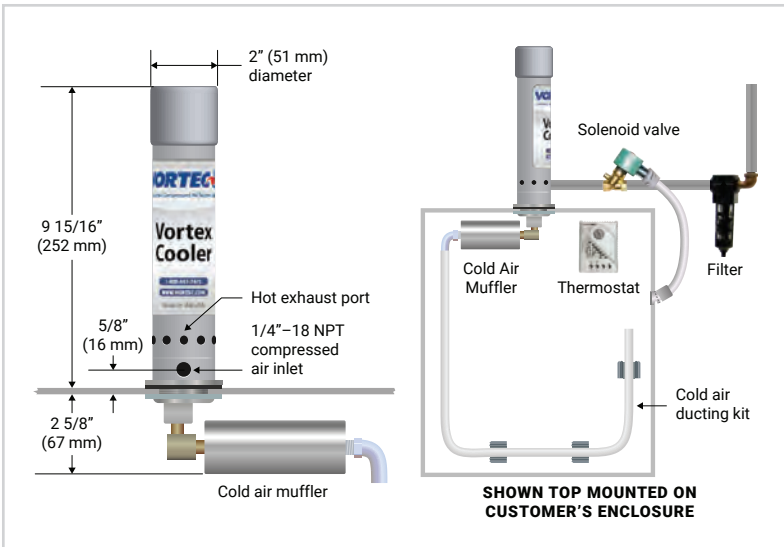

## Specifications

NEMA 12 Sound Level: Standard		
Model	Thermostat	Cooling Capacity BTU/hr (Watts)
750	Electric	400 (117)
740	Electric	900 (264)
790	Electric	1500 (440)
795	Electric	2500 (733)
7970	Electric	5000 (1465)
760	None	400 (117)
730	None	900 (264)
780	None	1500 (440)
785	None	2500 (733)
7870	None	5000 (1465)

NEMA 4 Sound Level: Standard		
Model	Thermostat	Cooling Capacity BTU/hr (Watts)
747	Electric	900 (264)
797	Electric	1500 (440)
797-35H	Electric	2500 (733)
7975	Electric	5000 (1465)
737	None	900 (264)
787	None	1500 (440)
787-35H	None	2500 (733)
7875	None	5000 (1465)

NEMA 4X Sound Level: Standard		
Model	Thermostat	Cooling Capacity BTU/hr (Watts)
747SS	Electric	900 (264)
797SS	Electric	1500 (440)
797SS-35H	Electric	2500 (733)
7975SS	Electric	5000 (1465)
737SS	None	900 (264)
787SS	None	1500 (440)
787SS-35H	None	2500 (733)
7875SS	None	5000 (1465)

# Accessories

## Thermostat Kits

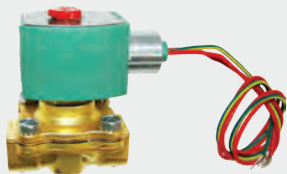

**Solenoid Valves**



**Thermostats**



**Thermostat Kits**

## Ducting Kits and Mufflers



**Cold Air Ducting Kit**



**Mufflers**

## Filters and Regulators



**701S-36A Filter**



**701S-54A Filter**



**208 RX Regulator**



# Other Vortec Products



**Vortex Tubes**



**Air Amplifiers and Jets**



**Personal Air Conditioners**



**Drum Pump**



**Cold Air Guns**



**Air Nozzles**



**Air Knives**



**Spray Nozzles**



**10125 CARVER RD. CINCINNATI, OH 45242**

**1.800.441.7475**

**[WWW.VORTEC.COM](http://WWW.VORTEC.COM)**